

NOTICE D'INSTALLATION
USER MANUAL
MONTAGEANLEITUNG

MANUAL DE INSTALACIÓN
Руководство пользователя

SERENITY

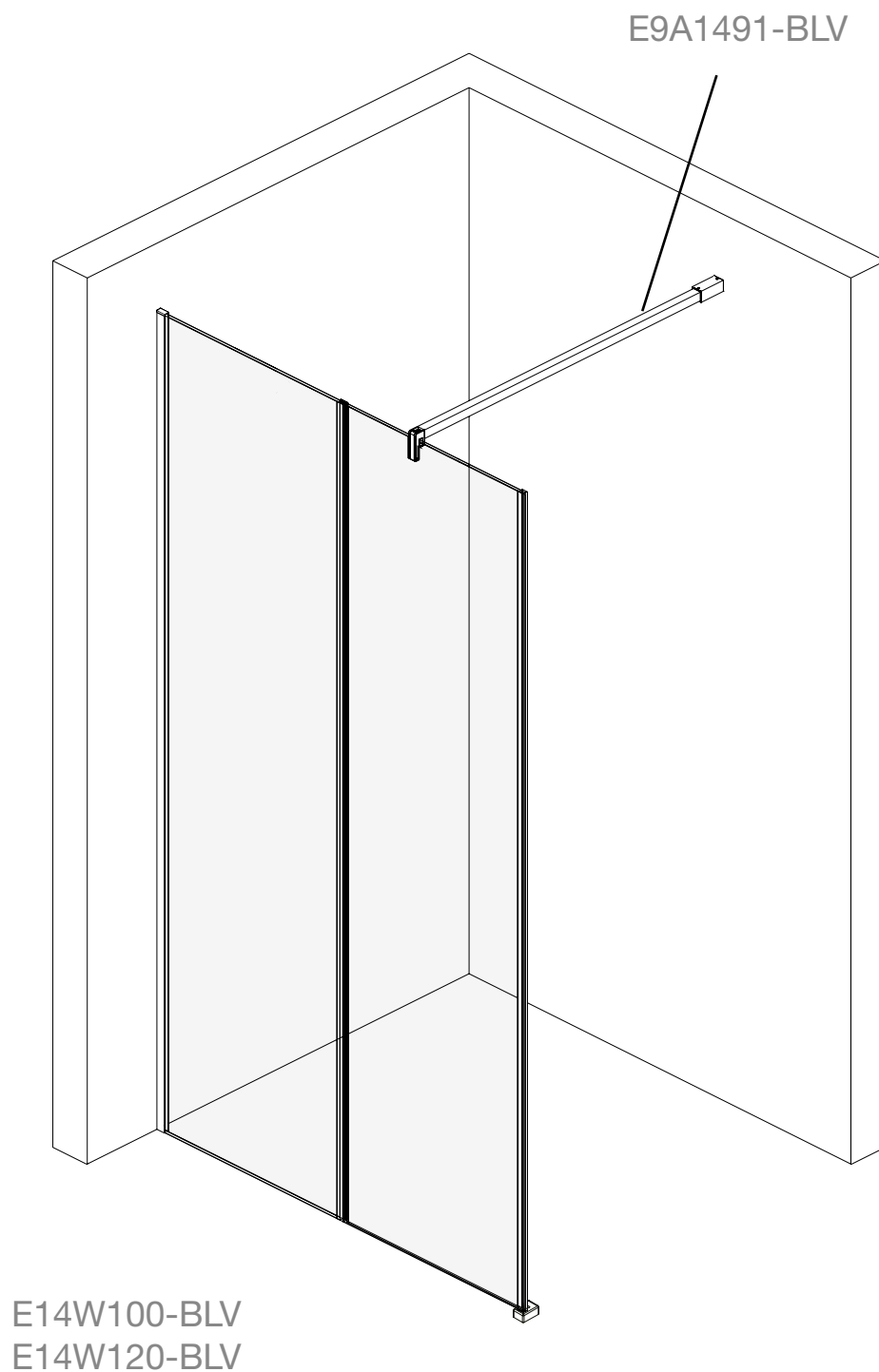

Jacob Delafon
PARIS

UK

Make sure that the item is installed by a competent installer. We strongly recommend that all glass panels are moved by a minimum of two people and that protective packaging along the glass edges is kept in place for as long as possible to prevent damage before installation.

Wear protective footwear when lifting panels.

Wear safety glasses when drilling. Observe all local plumbing and building codes.

FR

Assurez-vous que le produit est installé par une personne compétente. Nous conseillons la manutention de tous les panneaux en verre par deux personnes au minimum.

Il est recommandé de laisser tous les emballages de protection en place sur les arrêtes en verre.

Porter des chaussures de sécurité lors de la manutention des panneaux.

Porter des lunettes de protection lors du perçage.

Respecter tous les codes nationaux du bâtiment et de la plomberie.

D

Die Montage, darf nur durch einen geeigneten Fachmann durchgeführt werden. Wir empfehlen dringend, dass alle Glaspaneele von mindestens zwei Personen transportiert werden und dass die Schutzverpackung entlang der Glasskanten so lange wie möglich verbleibt, um eine Beschädigung vor dem Einbau zu verhindern.

Tragen Sie bei der Montage Sicherheitsschuhe.

Tragen Sie eine Schutzbrille, wenn Sie bohren.

Die Installation muss nach geltenden technischen Vorschriften durchgeführt werden.

ES

Asegúrese que el producto es instalado por personal preparado. Les aconsejamos que haya al menos dos personas para manejar los paneles. Es recomendable dejar todos los embalajes de protección y poner sobre ellos los paneles.

Lleve zapatos de seguridad mientras se manipule los paneles.

Colocarse gafas de protección a la hora de hacer agujeros.

Respete las normas nacionales de construcción y fontanería.

RU

Убедитесь, что о продукт установлен компетентным специалистом. Мы настоятельно рекомендуем перемещать все стеклянные панели бригадой в составе как минимум двух человек и не удалять защитную пленку со стекла в течение всего периода монтажа, чтобы предотвратить повреждение.

Носите защитную обувь при перемещении панелей.

Носите защитные очки при сверлении.

Соблюдайте все локальные строительные нормы.

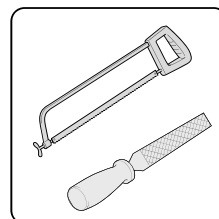
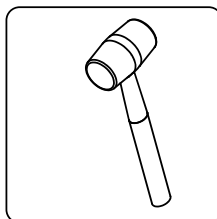
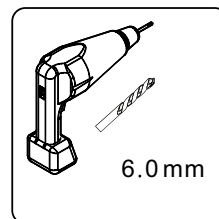
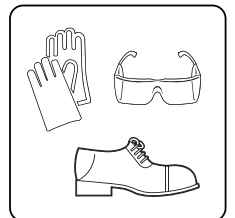
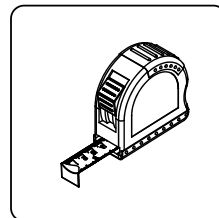
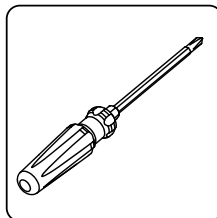
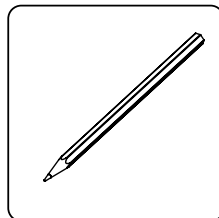
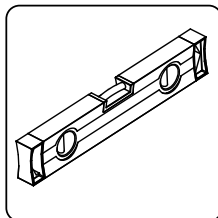
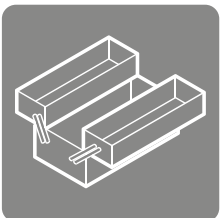



E14W100-BLV
E14W120-BLV

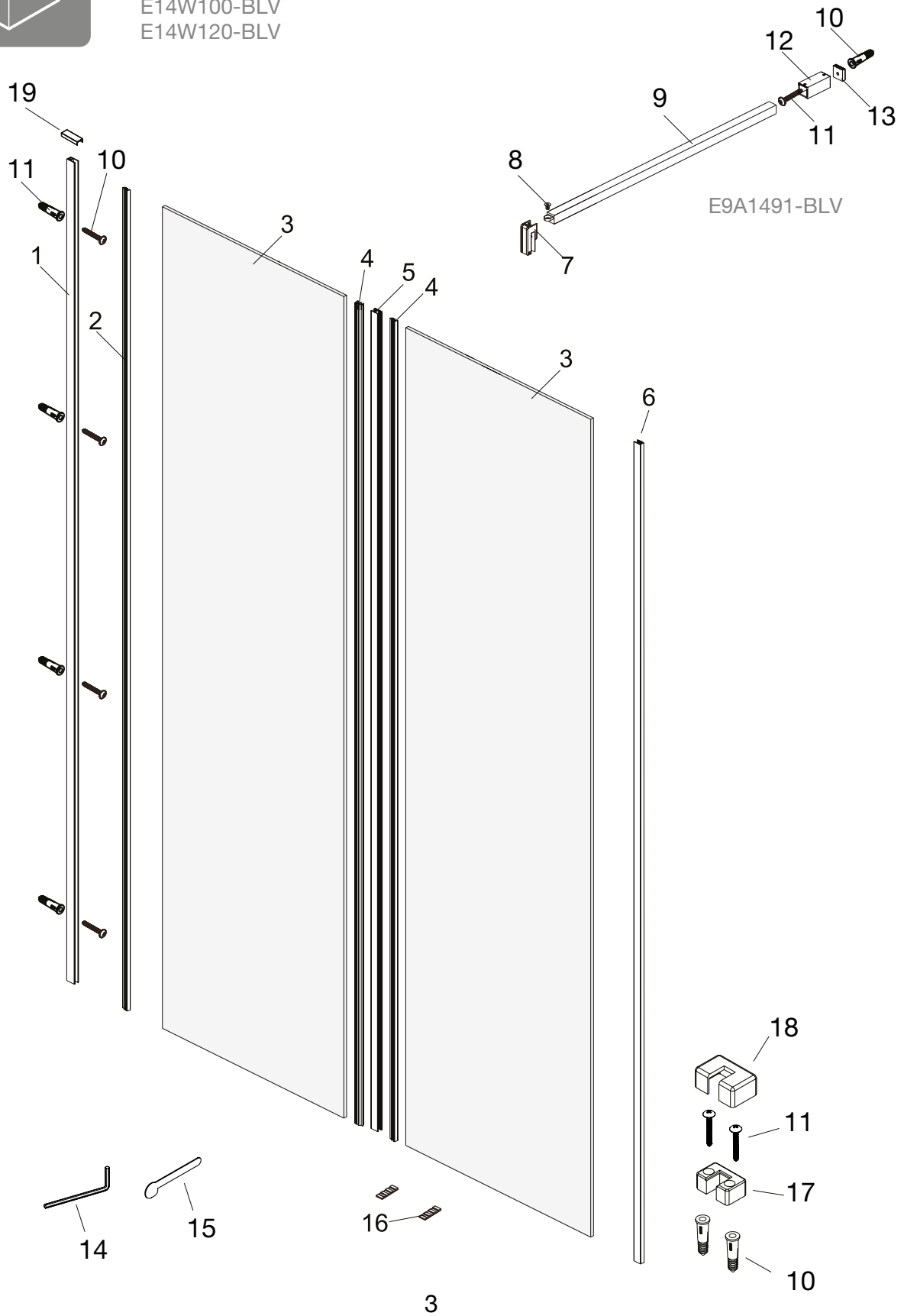

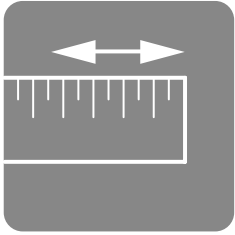

		X mm		Y mm	Z mm
		MIN	MAX	MAX	
E14W100-BLV	100	970	990	1020	13
E14W120-BLV	120	1170	1190	1020	13

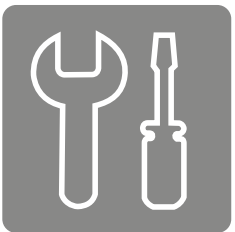
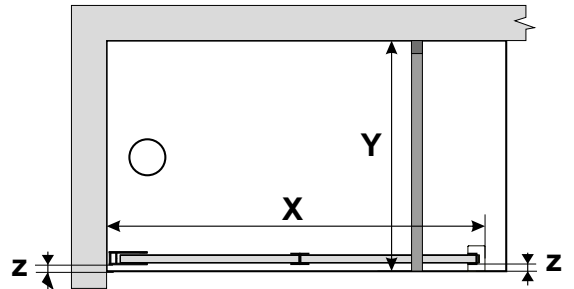
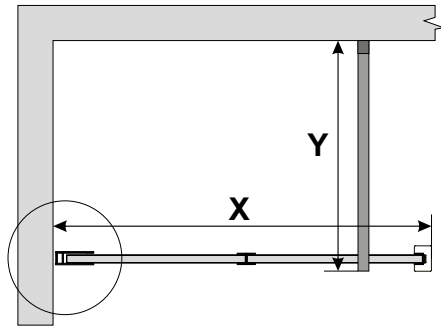
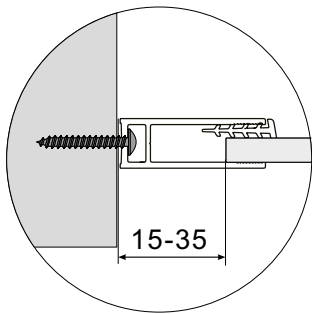

1

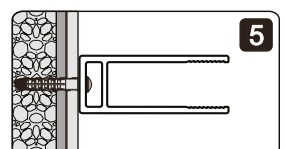
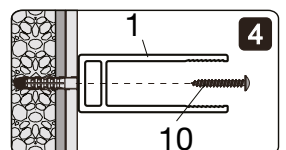
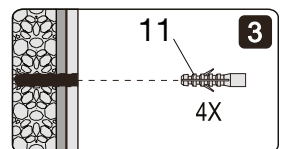
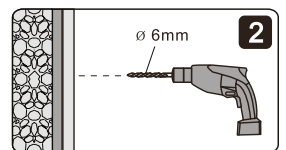
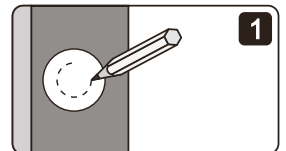
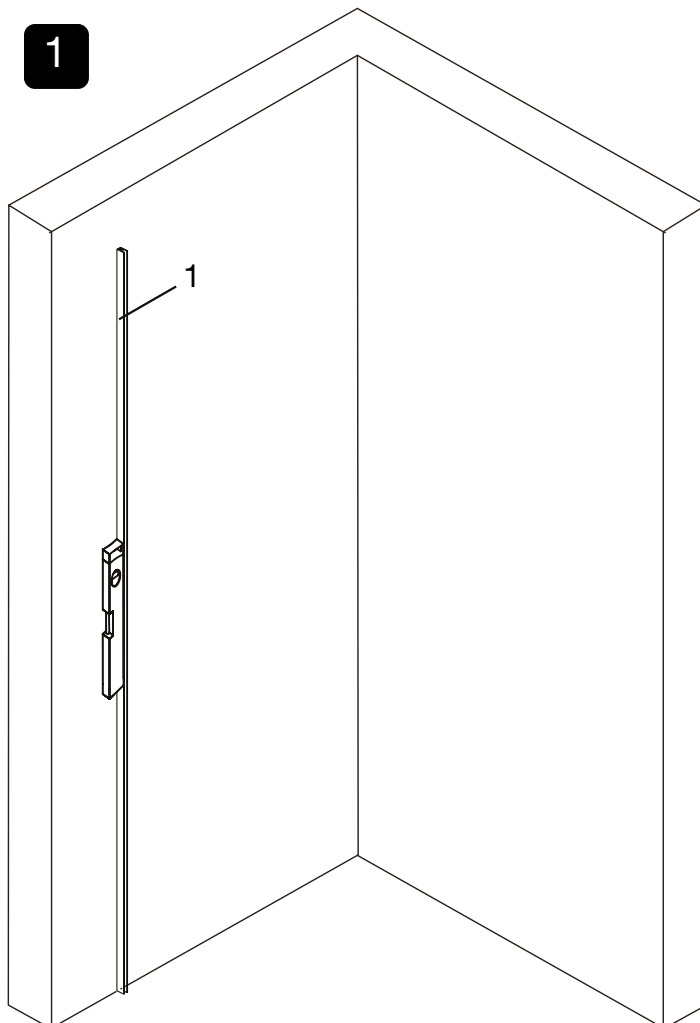

2

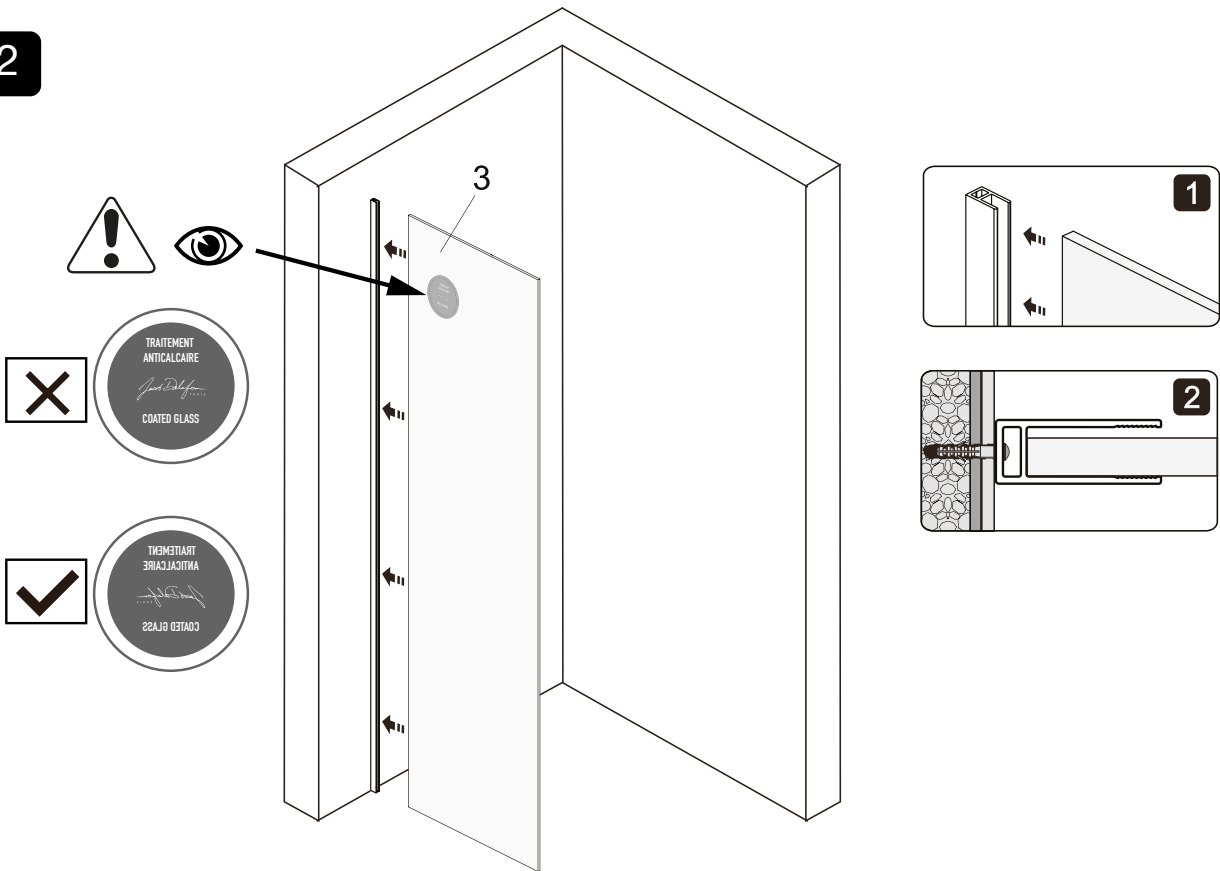

3

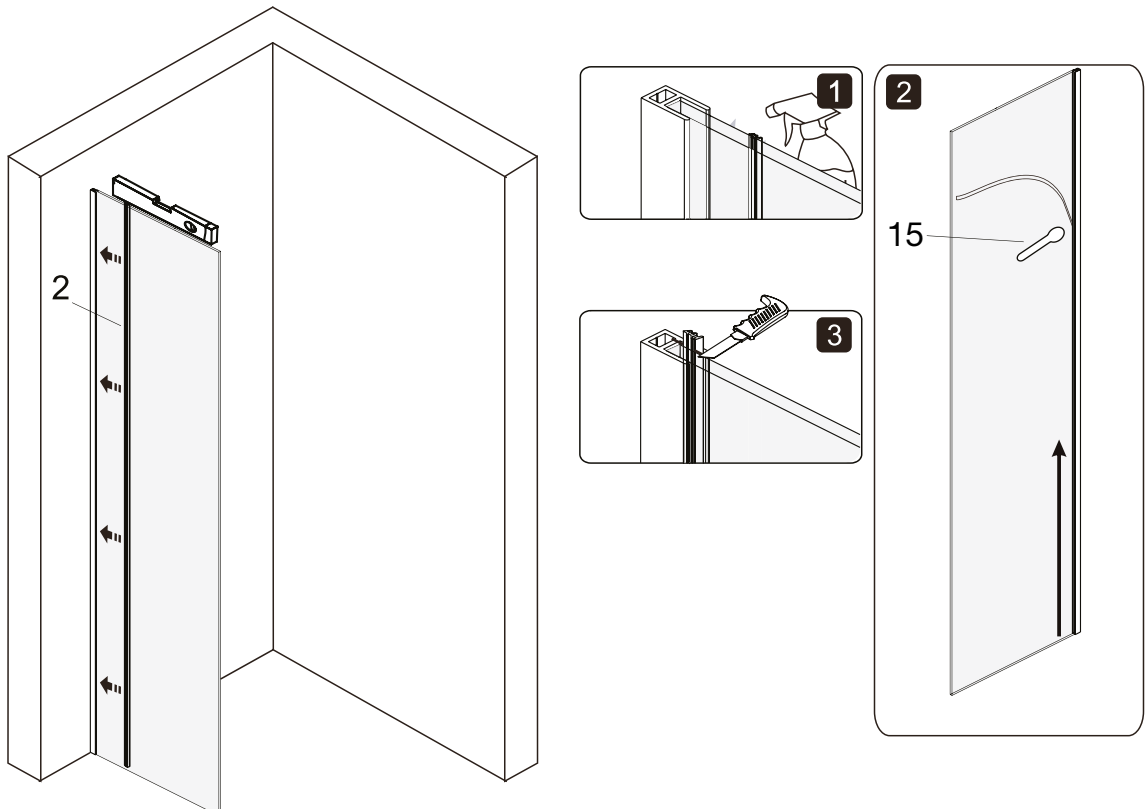

4

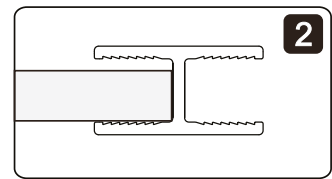
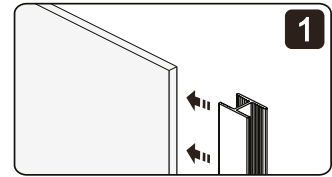
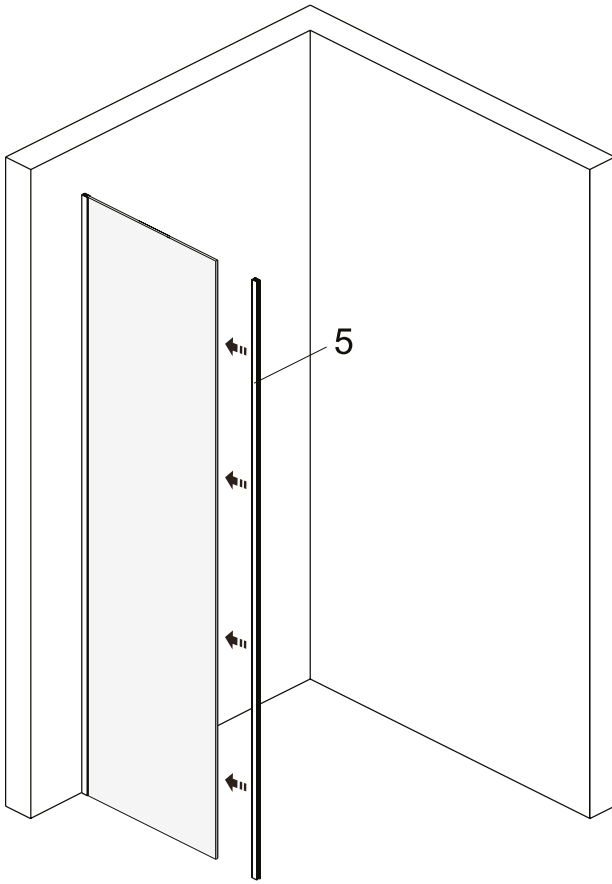

5

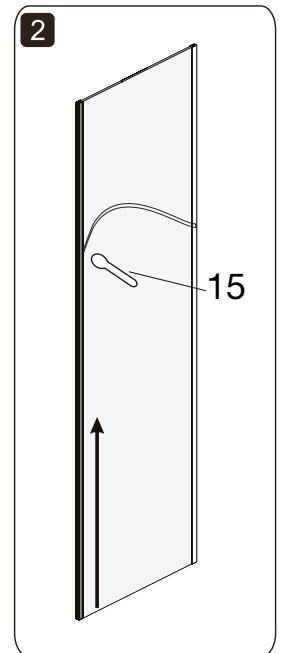
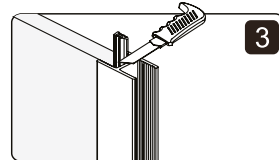
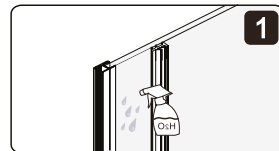
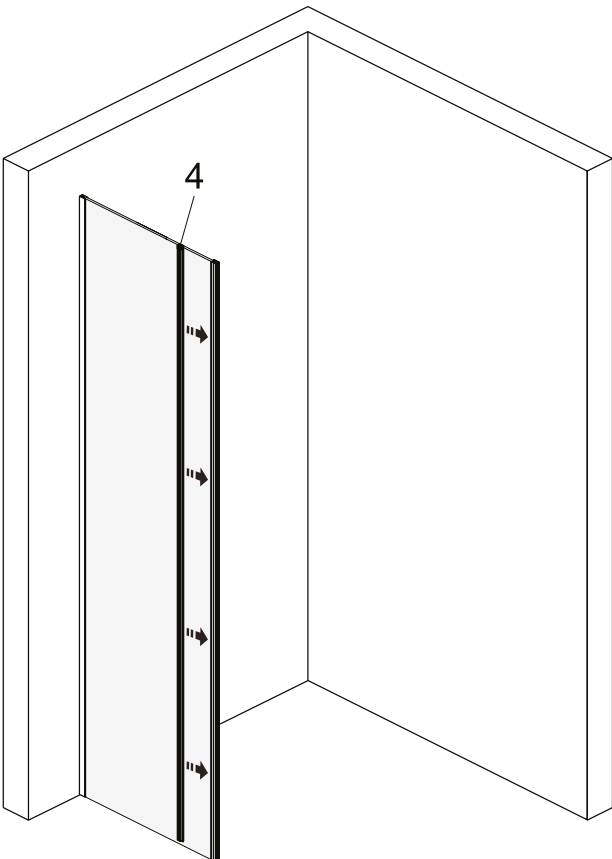

6

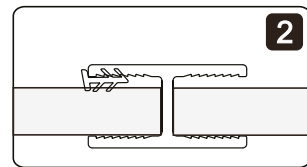
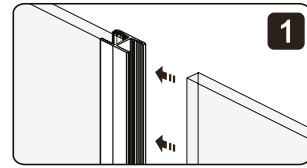
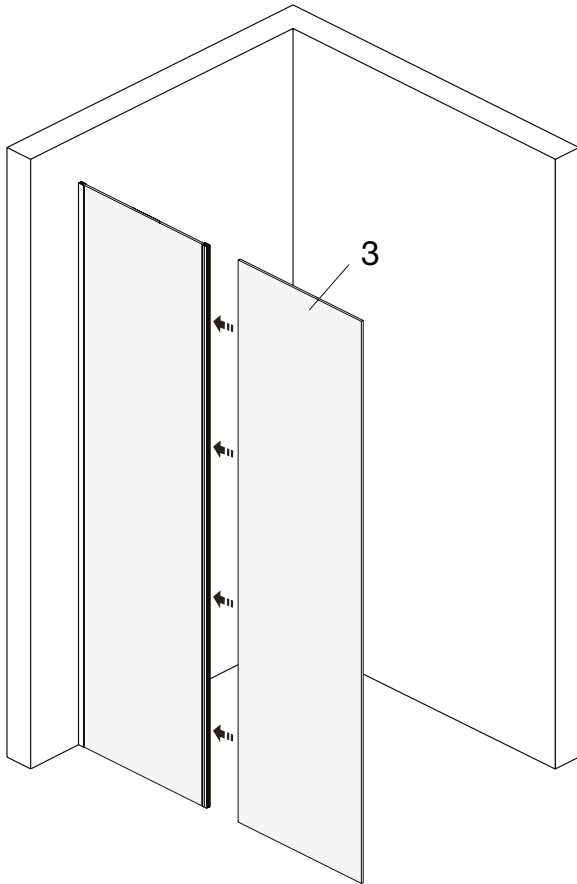

7

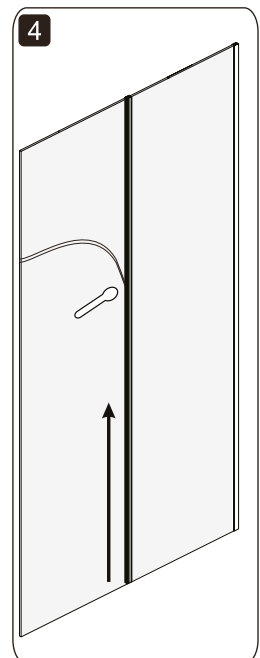
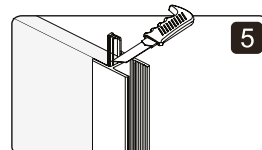
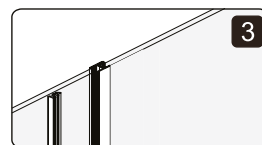
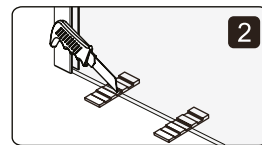
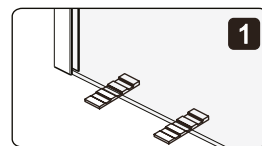
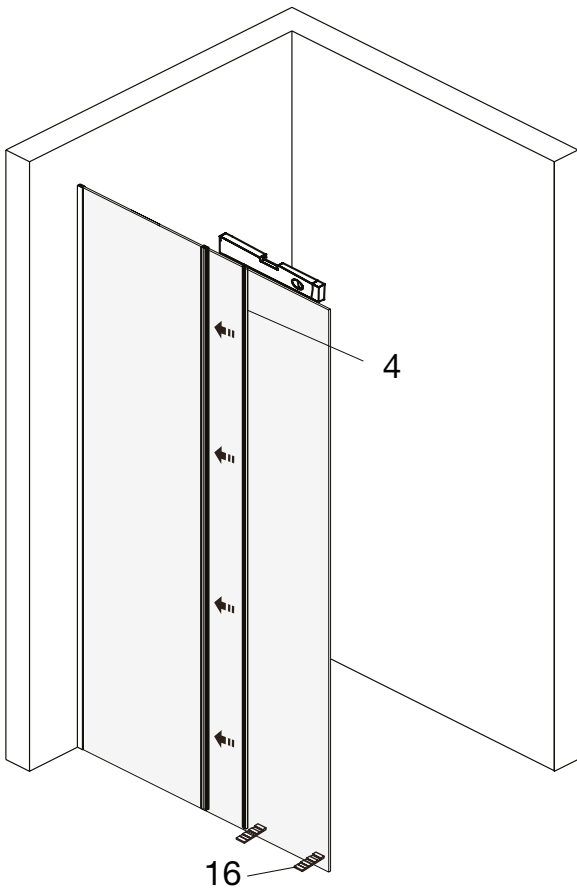

8

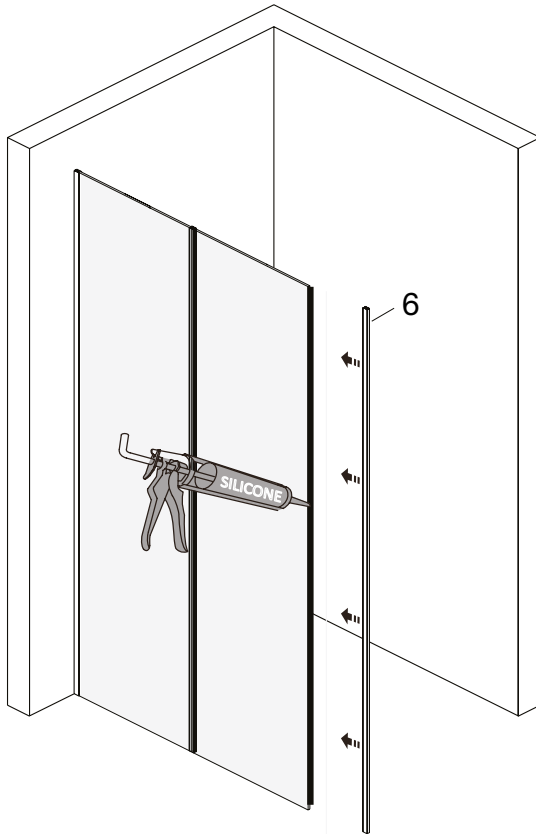

9

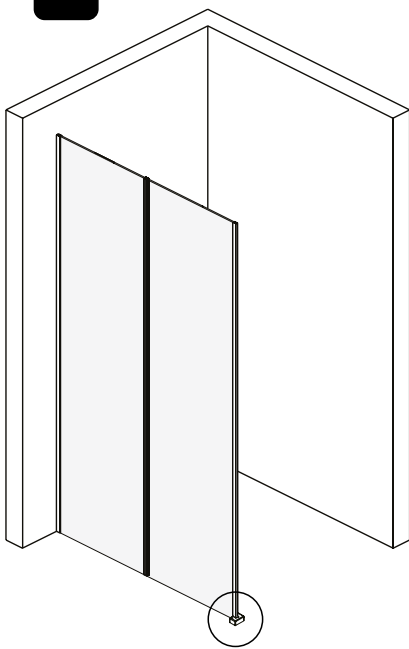

A

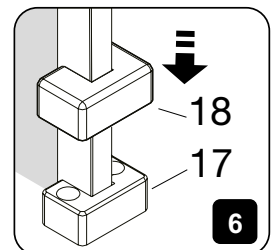
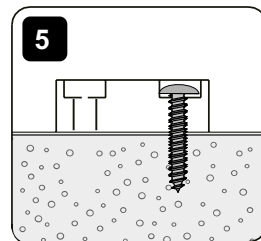
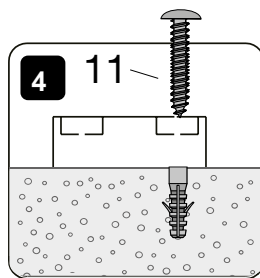
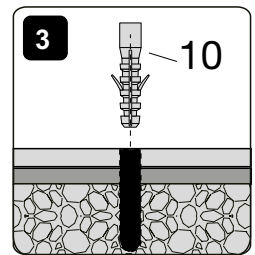
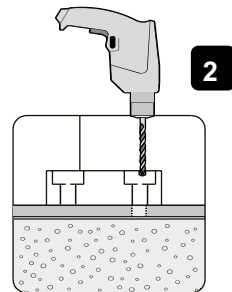
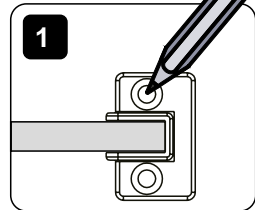

B

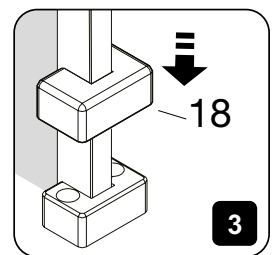
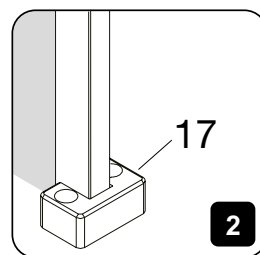
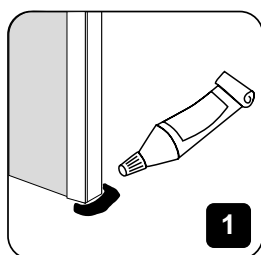

10

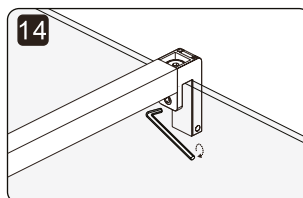
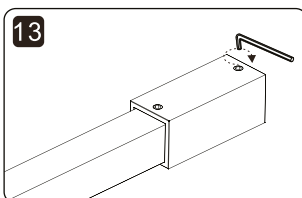
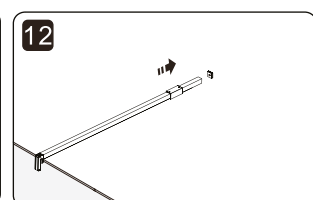
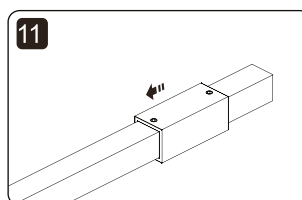
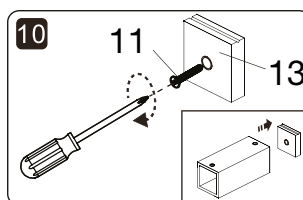
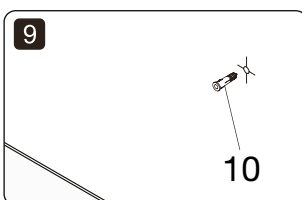
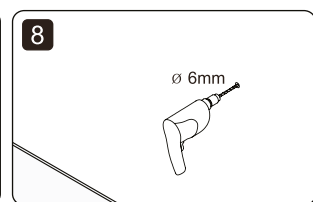
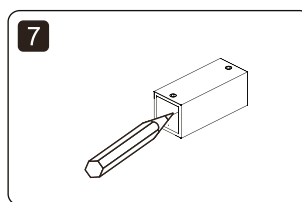
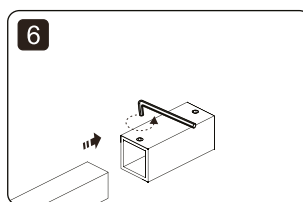
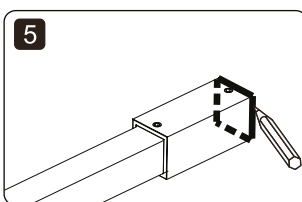
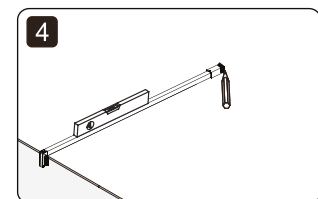
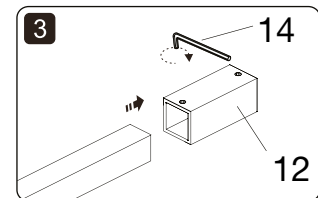
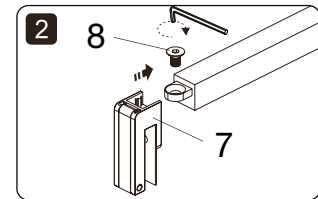
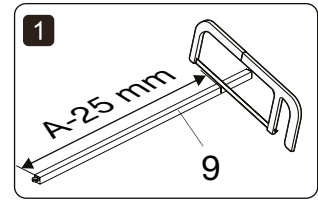
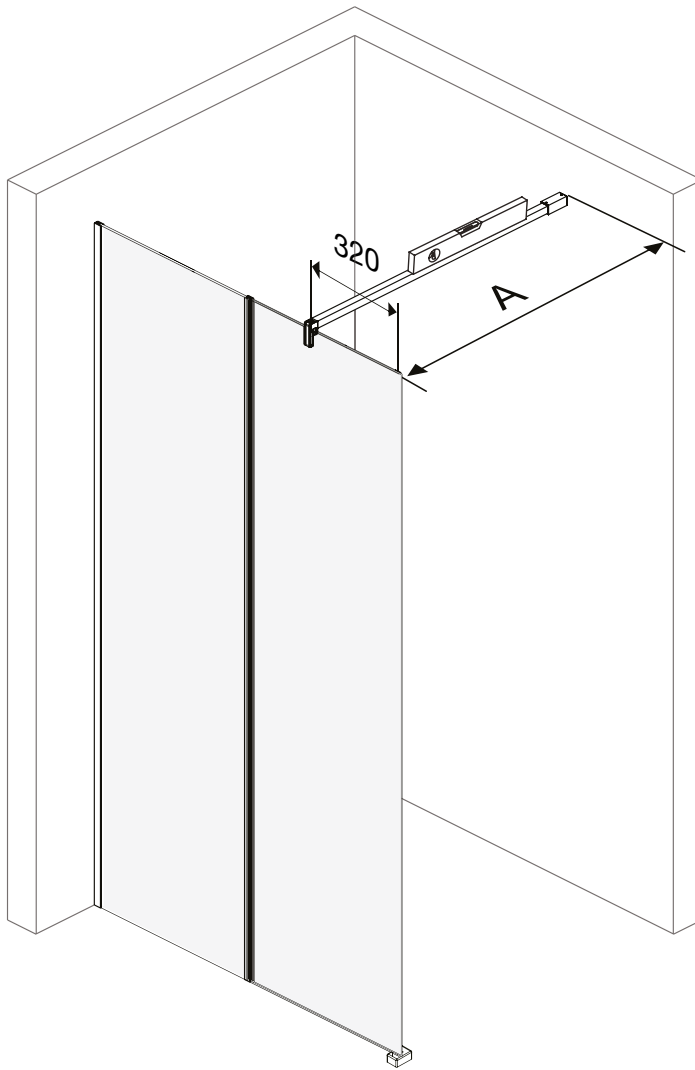

11

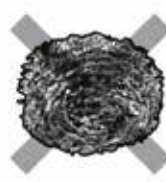
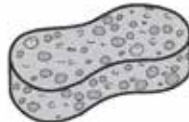
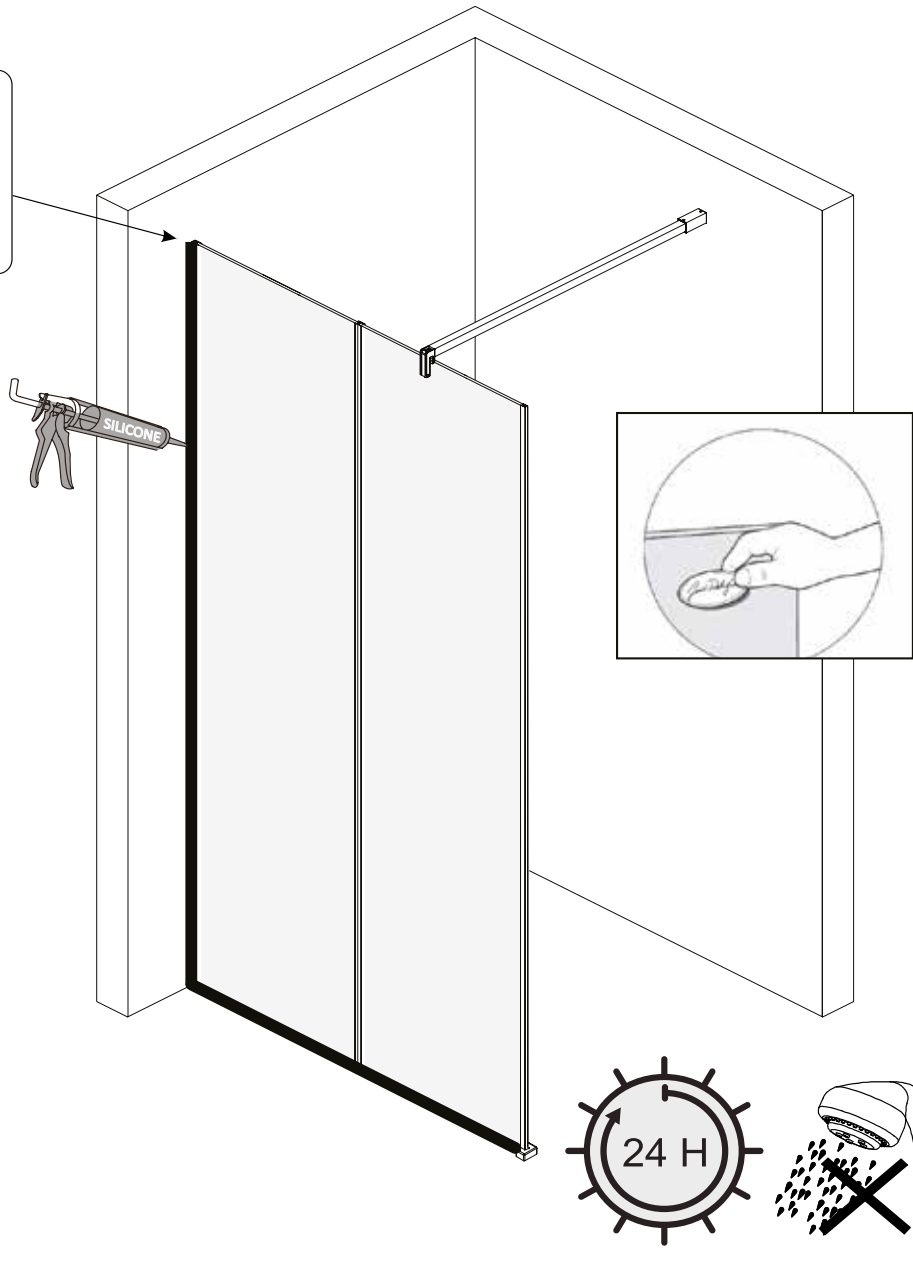
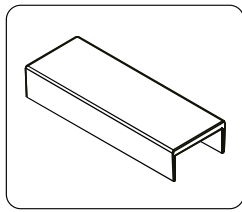

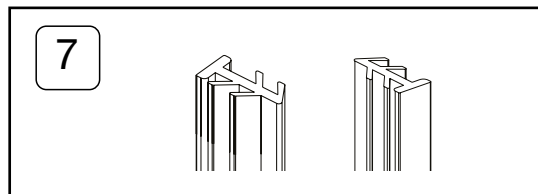
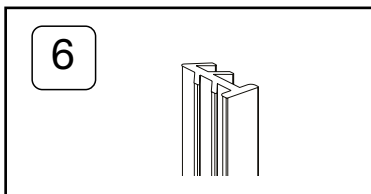
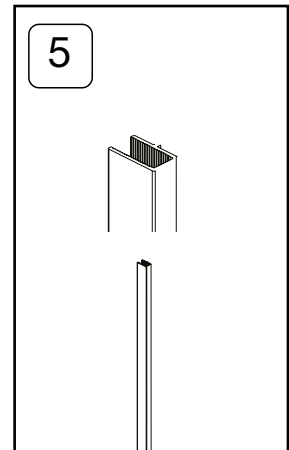
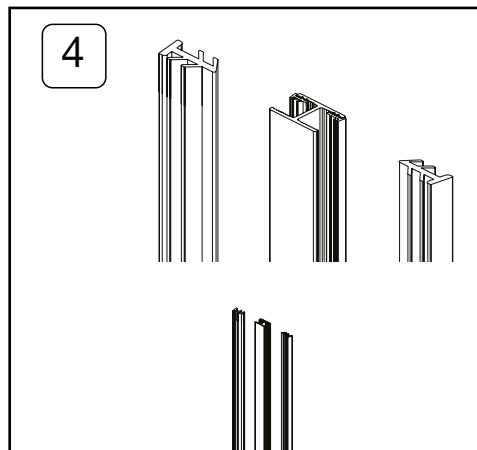
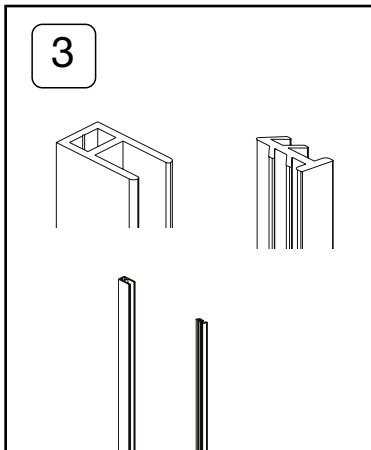
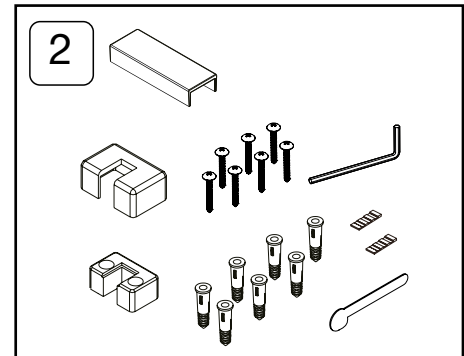
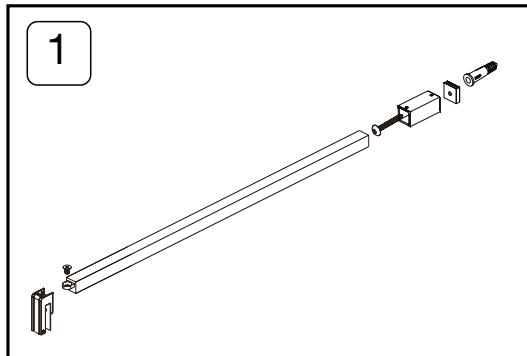

1	E9A1491-BLV	Barre de renfort, Bracing bar, Stütystab, Barra de refuerzo, Арматурный стержень
2	E9A1275-BLV	Sachet de visserie , Miscellaneous spare parts bag, Beutel mit ersatzteilsortiment Bolsa de piezas variadas, Сумка винтов
3	E9A1317-BLV	Profilé mural + joint, Door wall channel spare + seal, Wand profil + 2 Dichtung, Riel de pared + junta, Профиль стены + прокладка
4	E9A1485-BLV	Profilé H avec 2 joints, H profile with 2 seals, H profile mit 2 Dichtungen Perfil "H" + juntas, Профиль H + суставы
5	E9A1486-BLV	Profilé, End profile, Finalizar perfil, Abschlussprofil, Конечный профиль
6	E9A1479-BLV	Joint sapin, Seal, Dichtung, Junta de estanqueidad, Уплотнитель
7	E9A1492-BLV	2 joints sapin, 2 seals, 2 Dichtungen, 2 juntas de estanqueidad, 2 уплотнения



FR

Kohler Europe / Jacob Delafon France
3, rue de Brennus
93631 La Plaine Saint Denis Cedex
Tél. 03 25 70 91 25
Fax. 03 25 81 49 09
Email : asstecsav@kohlereurope.com
www.jacobdelafon.fr

M-E

Kohler Middle East
Al Thuraya Tower II, 9th Floor,
Office 905
P.O. Box 500431
DIC, Dubai, UAE
Tel. + 971-4-3624650
www.me.kolher.com

ES

Kohler / Jacob Delafon España
Ctra. de Logrono km. 17
50629 Sobradriel
Zaragoza
Tel. + 34 902 46 46 86
www.jacobdelafon.es

RU

Представительство KOHLER RUS
ул.1-я Бородинская, д. 2а , оф. 147
121059, Москва, Российская Федерация
Тел/Факс +7 495 7835223
www.jacobdelafon.ru

MA

Kohler / Jacob Delafon Maroc
207 Bd Anfa & rue Beaumarchais
Casablanca
Tel. +212 2 295 9740
www.jacobdelafon.ma

DE

Kohler Deutschland
Holtgrade 30
45739 Oer-Erkenschwick
Tel. +49 (0) 2368 9187 87
www.kohlerco.de

Merci d'avoir choisi la marque JACOB DELAFON

Votre produit est le fruit de notre savoir-faire et de notre passion pour le design et l'innovation. Nous sommes convaincus qu'il vous apportera toute satisfaction pour les années à venir.

Thank you for choosing JACOB DELAFON brand

This product reflects the true passion for design, craftsmanship, artistry and innovation this company stands for. We are confident its reliability and beauty will exceed your highest expectations, bringing you satisfaction for years to come.

Vielen Dank für Ihren Kauf eines JACOB DELAFON Produktes.

Ihr Produkt spiegelt Jacob Delafon Leidenschaft für Design, Komfort, Handwerkskunst und Innovationen wieder. Wir sind überzeugt, dass unser Produkt Ihren Erwartungen über Jahre entsprechen wird.

Gracias por elegir productos del marca JACOB DELAFON

Su producto refleja nuestra verdadera pasión por el diseño, la mano de obra, la artesanía y la innovación. Estamos seguros de que su fiabilidad y belleza excederá sus más altas expectativas dándole satisfacción por muchos años.

Благодарим Вас за выбор продукции компан ии JACOB DELAFON brand

Данный продукт отражает истинную страсть к дизайну, мастерству, стилю и инновациям, которые являются основными преимуществами нашей компании. Мы уверены, что его надежность и функциональность превзойдет все Ваши ожидания, не оставляя равнодушными долгие годы.

